

STEREO AMPLIFIER

 PIONEER®

SA-9800

S
S/G
HG

OPERATING INSTRUCTIONS



These operating instructions are based on the model HG, and they can be used for the S, S/G models. The differences between the models are given below.

Power requirements

SA-9800/HG: 220V/240V (switchable), 50Hz, 60Hz
SA-9800/S, S/G: 110V/120V/220V/240V (switchable), 50Hz, 60Hz

NOTE:

Read through the section on the *LINE VOLTAGE SELECTOR SWITCH* on page 5 before using your amplifier and check that the voltage selector switch is set correctly for use in your area.

Power cords

SA-9800/HG: This is configured as an AC inlet type. Use a separate power cord in order to connect the power supply.

SA-9800/S, S/G: The power cord is mounted at the rear.

Cabinet

SA-9800/HG, S: Black cabinet
SA-9800/S/G: Walnut grained finished cabinet.

Others

SA-9800/HG: The DIN-type recording/playback socket is provided on the rear panel.

SA-9800/S, S/G: The AC outlets are provided on the rear panel.

IMPORTANT

To prevent electric shock, do not remove cover. No user serviceable parts inside, refer servicing to qualified service personnel.

Always disconnect all the equipment from the mains supply when disconnecting the signal leads. The power cord should be connected last, make sure that the power switch is off. First, insert the female appliance connector of the mains cord into the AC INLET, then plug the cord to the wall socket. Be sure that the appliance connector is fully inserted into the AC INLET.

Unplug the set from the wall socket when it is not to be used for an extended period of time.

WARNING

THIS APPARATUS MUST BE EARTHED.

FOR YOUR SAFETY

1. Insert this plug only into effectively earthed three-pin plug-socket outlet.
2. If any doubt exists regarding the earthing, consult a qualified electrician.
3. Extension cords, if used, must be three-core correctly wired.

FOR USE IN UNITED KINGDOM AND AUSTRALIA

CAUTION 240V: Mains supply voltage is factory adjusted at 240V.

FOR USE IN UNITED KINGDOM

The wires in this mains lead are coloured in accordance with the following code:

Green-and-Yellow: Earth
Blue: Neutral
Brown: Live

As the colours of the wires in the mains lead of this apparatus may not correspond with the coloured marking identifying the terminals in your plug proceed as follows.

The wire which is coloured green-and-yellow must be connected to the terminal which is marked with the letter E or with the safety earth symbol \perp or coloured green or green-and-yellow.

The wire which is coloured blue must be connected to the terminal which is marked with the letter N or coloured black.

The wire which is coloured brown must be connected to the terminal which is marked with the letter L or coloured red.

CONTENTS

Features	2	Effective Operations	12
Stereo System Composition	3	Using the Tape Decks	13
Installation Precautions	3	Using PRE OUT and POWER AMP IN Jacks	14
Rear Panel Facilities	4	Conditions Frequently Mistaken for Malfunctions	15
Connections	5	Specifications	16
Front Panel Facilities	8	Schematic Diagram	Insertion
Operations	11		

FEATURES

Power Amplifier with Ultra-wide-frequency-band Output and Low Distortion

This amplifier has the impressive feature which is the NSA (Non-Switching-Amplifier), created specially by Pioneer. This is a type of amplifier that adopts the merits of both the class A and class B amplifiers, and it excels in keeping down the heat loss and allows the transistors to operate all the time in the active region. For this reason, a high output power with a very low distortion factor is yielded all the way up to the high frequencies.

Also it is designed to pack a punch at every stage — this is evident in the first stage differential input, current mirror load; the predriver stage emitter follower drive, constant-current load; and the output stage 2-stage Darlington, parallel push-pull output circuit configuration. All this adds up to a DC amp configuration which uses SL RETs (Super Linear Ring Emitter Transistors), which have an excellent switching response in the high frequency range, for the power transistors.

Continuous Power Output is 100watts* per channel, min., at 8 ohms or 4 ohms from 10 Hertz to 20,000Hertz with no more than 0.005% total harmonic distortion.

T-shaped "skyyve" heat sink is used because it is lightweight and it dissipates the heat very effectively. Even when the amplifier is operating continuously under full power conditions, these heat sinks keep the rise in temperature down, and they ensure that a high-quality power is provided.

Flat Amplifier with High S/N Ratio and Low Distortion

This model adopts an ICL DC amplifier which is composed of a two-stage differential amplifier for the first stage using ultra-low-noise dual FETs and an emitter follower for the final stage. This construction is successful in achieving a low distortion and a high signal-to noise ratio, and in maintaining an S/N ratio of 110dB (AUX).

Equalizer Amplifier for Faithful Reproduction of Sound from Records

The equalizer amplifier is composed of a complementary differential input which uses ultra-low-noise transistors for the first stage, and a 3-stage direct-coupled all-stage push-pull configuration. This results in yielding a low noise and low distortion, a signal-to-noise ratio of 90dB (PHONO) and an RIAA equalization of only ± 0.2 dB across a frequency spectrum of 20Hz to 20kHz. The maximum rated input is 250mV/MM (at 1kHz, 0.002% total harmonic distortion) and 10mV/MC, proving that there is more than enough headroom for the reproduction of sound from records.

Load Impedance Selector Switches

This amplifier comes with cartridge load selectors which make it possible to display the performance of moving magnet (MM) cartridges to the full for sophistication in operation. The load resistance selector has five settings (100/10k/25k/50k/100k ohms) and the load capacitance selector similarly has five settings (100/200/300/400/500pF), so that the two selectors can be used independently. They allow you to make settings which are in line with the optimum values of the phono cartridge you are using and also to create the sound quality of your choice.

Another feature is the MC position which means you can connect a moving coil (MC) cartridge with a subtle and delicate sound quality directly. All you have to do to derive the maximum in enjoyment from your MC cartridge is set the function selector to the PHONO 2 MC position.

Power Output Indication on Fluorescent Display Tubes

The conventional needle-type of power output meters have been replaced with the more up-to-date fluorescent display tubes featuring digital technology. They employ logarithmic compression circuits and a peak hold circuit to indicate the power output over a 0.3mW to 100W range without any assisting selection on the attractive fluorescent display tubes.

STEREO SYSTEM COMPOSITION

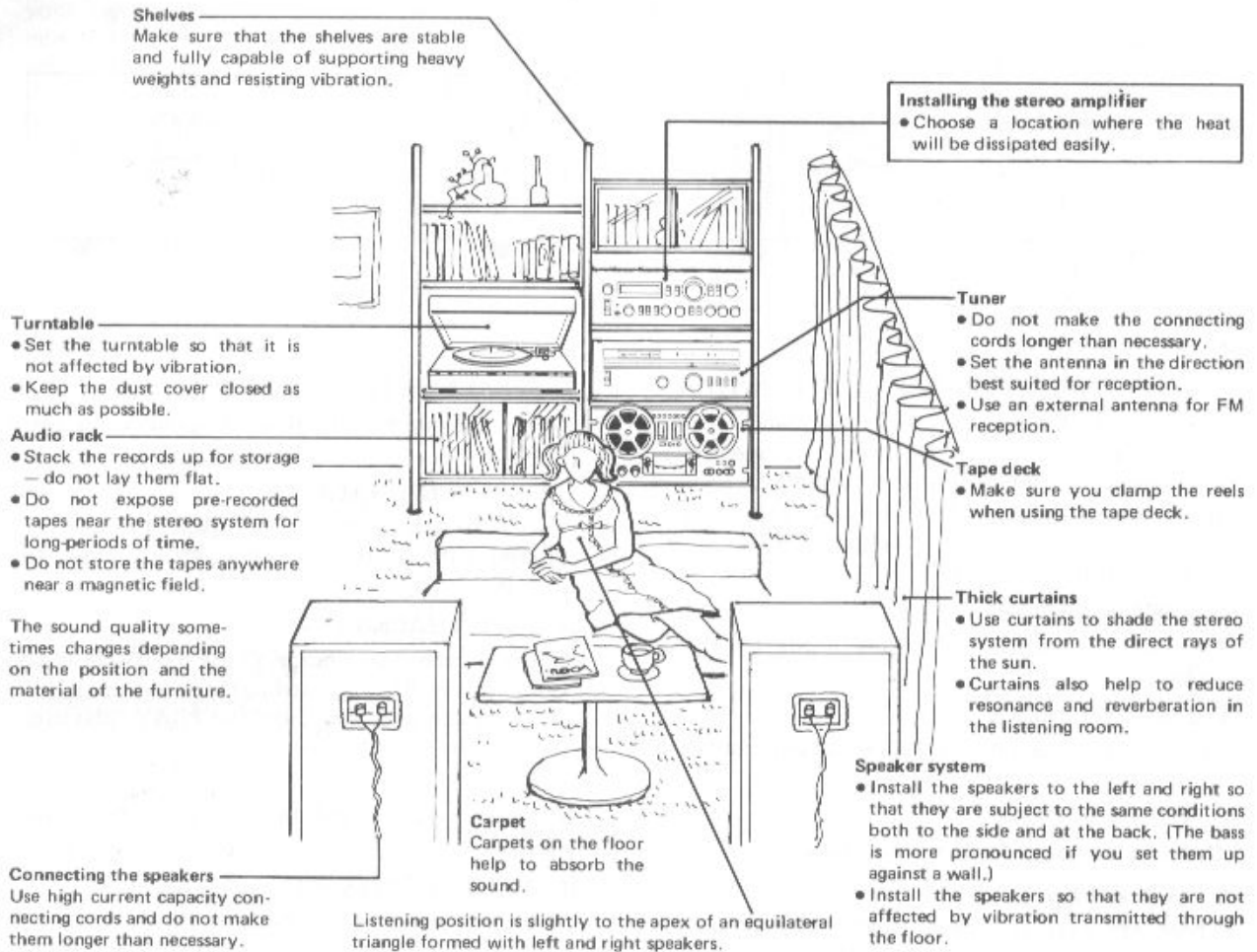

INSTALLATION PRECAUTIONS

To ensure the best sound quality and trouble-free operation, avoid setting up the amplifier in any of the locations described below:

Locations liable to downgrade performance and result in breakdowns	Resulting trouble
<ol style="list-style-type: none"> 1. Locations exposed to direct sunlight, or near heaters. 2. Locations with poor ventilation, with high humidity or moisture contents, or dusty locations. 3. Locations susceptible to vibration. 	<ol style="list-style-type: none"> 1. External heat causes the performance of the electronic parts to deteriorate, and operation becomes unstable. 2. Cause of faulty contact in input-output terminals, and rust. High humidity and a high moisture content cause deterioration in insulation. There is also the danger of current leakage and heat generation in the circuit parts. Dust or grease in the rotating parts causes them to deteriorate. 3. These locations affect the precision parts adversely.

REAR PANEL FACILITIES

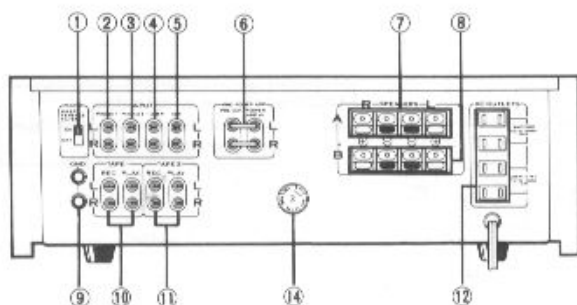

SA-9800/S, S/G model

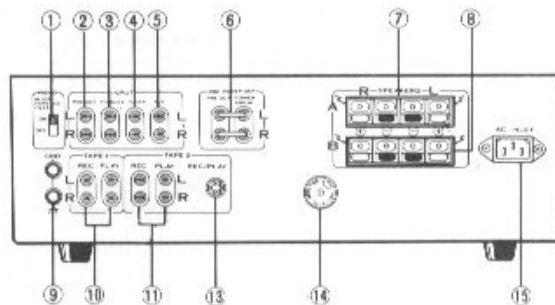

SA-9800/HG model

① PHONO INTERFERENCE FILTER SWITCH

This is used to attenuate radio-frequency interference from external electronic or electrical appliances or products during record play.

When this switch is set to ON during record play with the cartridge load resistance switch is at 100Ω position, the sound volume will be reduced.

② PHONO 1 JACKS

Connect the turntable output cords to these jacks.

③ PHONO 2 JACKS

Connect your second turntable output cords to these jacks.

④ TUNER JACKS

Connect the tuner cords to these jacks.

⑤ AUX JACKS

These are auxiliary input jacks. Connect a TV tuner or cartridge tape player to them.

⑥ PREAMPLIFIER/POWER AMPLIFIER CONNECTOR BAR

When this connector bar is disconnected from the jacks, you can separate the SA-9800's preamplifier and power amplifier. For normal use, however, it is connected. For details on how to use this bar, refer to page 14 and "Using PRE OUT and POWER AMP IN jacks".

NOTE:

If this bar is not connected properly, you will not hear any sound from the speakers connected to the SPEAKERS terminals.

⑦ SPEAKERS TERMINALS A

Connect your first pair of speakers to these terminals.

⑧ SPEAKERS TERMINALS B

Connect your second pair of speakers to these terminals.

⑨ GND TERMINALS

These are the ground terminals. Connect the ground wire of the turntable, etc. to these terminals.

⑩ TAPE 1 JACKS

Connect the tape deck cords to these jacks. Connect the REC (recording) jacks to the INPUT jacks on the tape deck, and the PLAY (playback) jacks to the OUTPUT jacks.

⑪ TAPE 2 JACKS

Connect your second tape deck cords to these jacks.

⑫ AC OUTLETS (S, S/G models only)

These are spare power outlets. Insert the power plug on the stereo components (turntable, tuner, tape deck, etc.) into these outlets.

SWITCHED: The power supplied through these outlets is coupled to the operation of the amplifier's power switch. The maximum power capacity which may be connected to the two SWITCHED outlets is 200W.

UNSWITCHED: The power is always supplied through these two outlets regardless of the position of the power switch. The maximum power capacity which may be connected to these two outlets is 200W.

NOTES:

- Never connect an iron or a toaster to these outlets.
- Do not get the power outlets and the power plugs wet or touch them with wet hands, since you may get an electric shock.

⑬ TAPE 2 JACK (HG model only)

Connect the tape deck to this jack with DIN-type (recording/playback) cord.

⑭ LINE VOLTAGE SELECTOR SWITCH

Check that the indication of the switch is same as your residence before plugging the power cord into the outlet. If it isn't or if you move to an area where the voltage requirements differ, change the switch setting as follows.

Before adjusting, disconnect the power cord.

HG model (220V/240V switchable)

1. Loosen the screw on the plug with a Phillips screwdriver, then take out the plug.
2. Re-install the plug with its cutaway section exposing the correct voltage indication as shown in Fig.A.
3. Tighten the mounting screw.

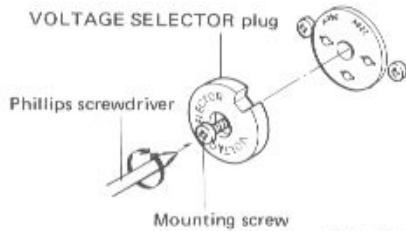

Fig. A

S, S/G model (110V/120V/220V/240V switchable)

1. Unscrew the fuse cap with a Phillips screwdriver, then take out the fuse and plug.
2. Re-install the plug with its cutaway section exposing the correct voltage indication as shown in Fig.B.
3. Refer to the table and install a replacement fuse (provided as an accessory).
4. Insert the fuse in the fuse cap, then fit the cap to the plug and tighten.

Voltage	Fuse
110V, 120V	10A
220V, 240V	5A

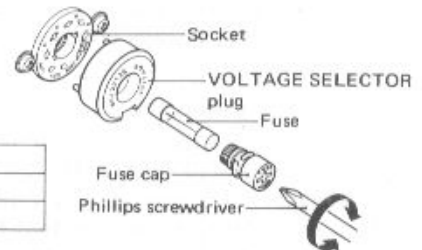

Fig. B

⑮ AC INLET (HG model only)

Plug the power cord into this socket.

CONNECTIONS

CONNECTION DIAGRAM

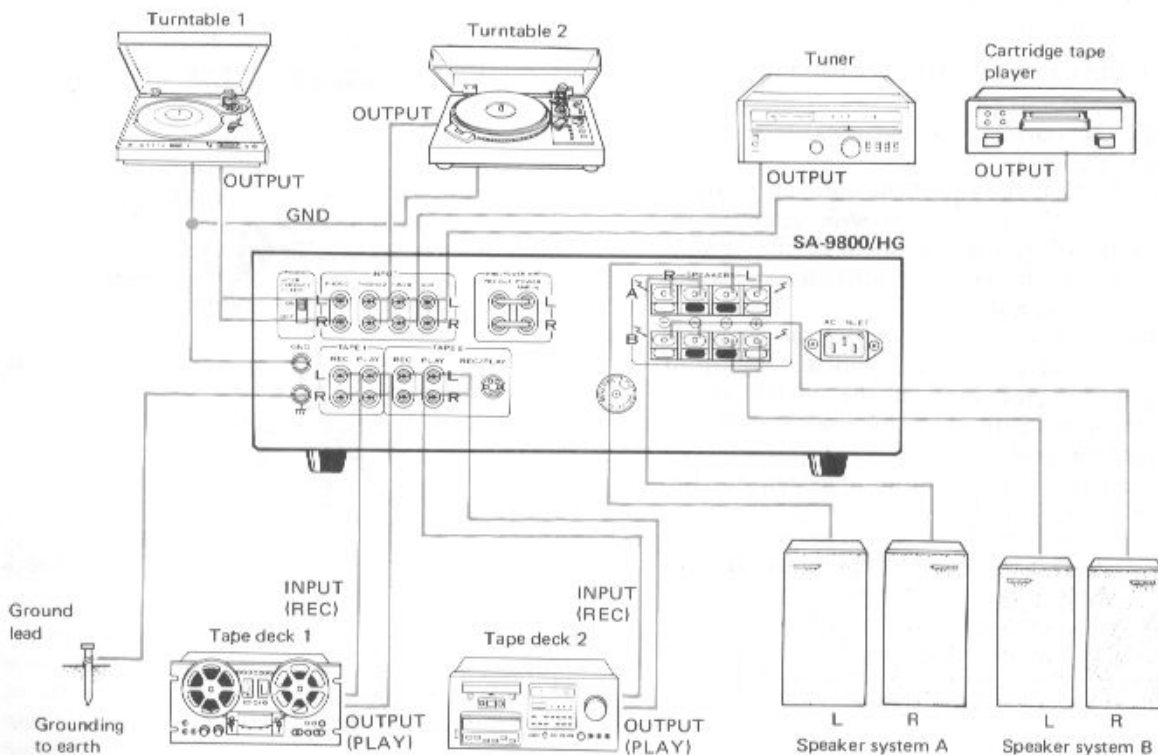

SPEAKER SYSTEM CONNECTIONS (Fig. 1)

The amplifier is provided with two sets of SPEAKERS output terminals. Use the A set when connecting only one set of speakers. Viewed from the front, the R (right channel) SPEAKERS terminals are on the right and the L (left channel) SPEAKERS terminals are on the left. Connect the left channel speaker to the L terminals and the right channel speaker to the R terminals. The red L and R SPEAKERS terminals have a plus polarity and the black terminals have a minus polarity and the speaker systems have also the same dual polarities. When connecting, always connect minus to minus and plus to plus.

Cautions when connecting the speakers

1. The speaker output terminals have polarities: minus (black) and plus (red). The input jacks on the speakers also have plus and minus polarities. When connecting, make sure that these polarities are aligned: plus to plus and minus to minus. If the left and right speaker polarities are misaligned, the reproduced sound will not display a natural stereo effect.
2. Use speakers with a nominal impedance ranging from 4 ohms to 16 ohms.
3. Never use the speakers with the speaker output terminals shorted (minus and plus jacks connected) since this may damage the power transistors in the amplifier.

Processing and connecting the speaker cords (Fig. 2)

1. Cut off the covering of the speaker cords as shown in Fig. 2-①.
2. If the strands at the tip of the cord are pointing in all directions, twist them with your thumb and forefinger. Otherwise some of the strands may come into contact with other terminals and cords, and cause a short.
3. Push down on the buttons under the terminals with the tip of your finger, and slip the tip of the cord into the hole in the center of the terminal. Make sure that the lead wire in the cord does not protrude.
4. Remove your fingertip from the button. The terminal will snap back into position and so check that the cord is securely connected. You may not hear any sound if the cords are not connected properly.

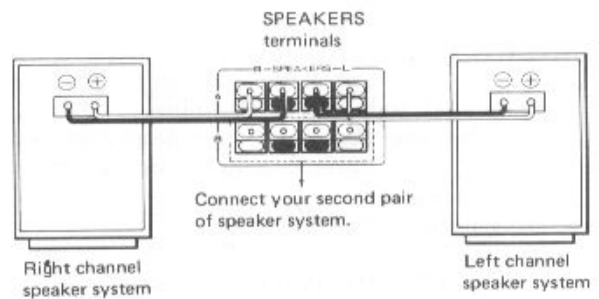

Fig. 1

Speaker lead wire preparation and connection

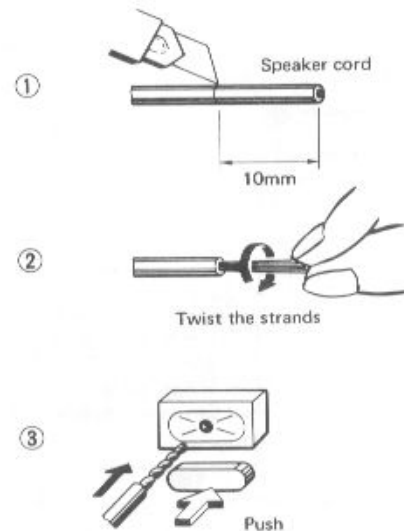

Fig. 2

TURNTABLE CONNECTIONS (Fig. 3)

Connect the output cords of a turntable to the PHONO 1 input jacks. Connect the ground lead of the turntable to the GND terminal on the amplifier.

This stereo amplifier contains a built-in amplifier for MC cartridges. This means that you can use moving coil (MC), moving magnet (MM), moving iron (MI), and induced magnet (IM) cartridges on your turntable.

NOTES:

1. Connect the turntable with MC cartridge to the PHONO 2 input jacks.
2. If your turntable is fitted with two tonearms, the output cords for each of the tonearms should be connected to the PHONO 1 and PHONO 2 input jacks.

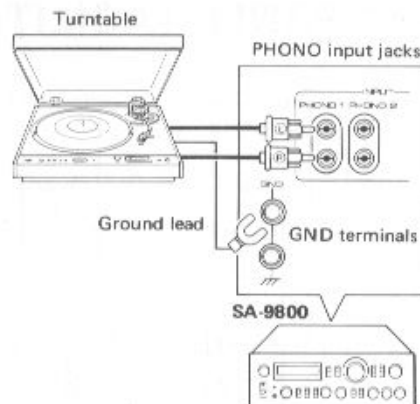

Fig. 3

TUNER CONNECTIONS (Fig. 4)

Connect the output jacks of a stereo tuner to the TUNER input jacks with the connecting cords.

AUX JACKS CONNECTIONS (Fig. 5)

These jacks can be connected to the OUTPUT (PLAY) jacks on a TV tuner, cartridge tape player or tape deck. Use connecting cords with pin plugs to connect the OUTPUT jacks on the component with the AUX jacks.

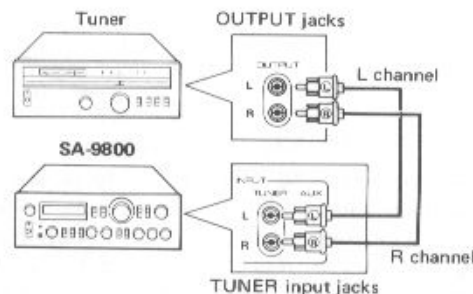

Fig. 4

TAPE DECK CONNECTIONS (Fig. 6)

This amplifier is provided with two sets of recording (TAPE REC) output jacks and two sets of playback (TAPE PLAY) input jacks. Connect each of the jacks in the following way using the connecting cords which come with the tape deck.

Connections for recording

Connect the recording input jacks (INPUT) on the tape deck to the TAPE REC jacks on the amplifier.

Connections for playback

Connect the playback output jacks (OUTPUT) on the tape deck to the TAPE PLAY jacks on the amplifier.

NOTE:

Connect your second tape deck to the TAPE 2 jacks (REC, PLAY).

Connections using the recording/playback connector (Applicable to HG model only)

If your tape deck is equipped with a recording/playback connector (DIN-type), use the optional recording/playback cord to connect this connector with the TAPE 2 REC/PLAY jack on the amplifier. In such cases, do not connect pin cords (ordinary pin plug cords) to the TAPE 2 REC and PLAY jacks.

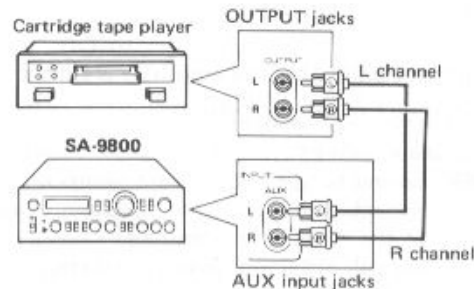

Fig. 5

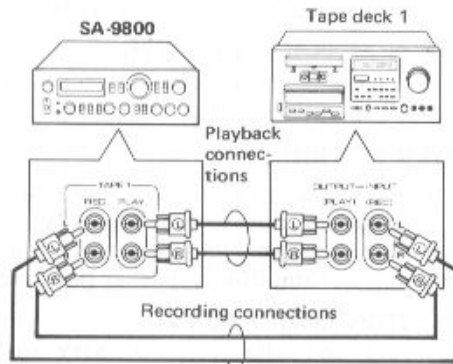
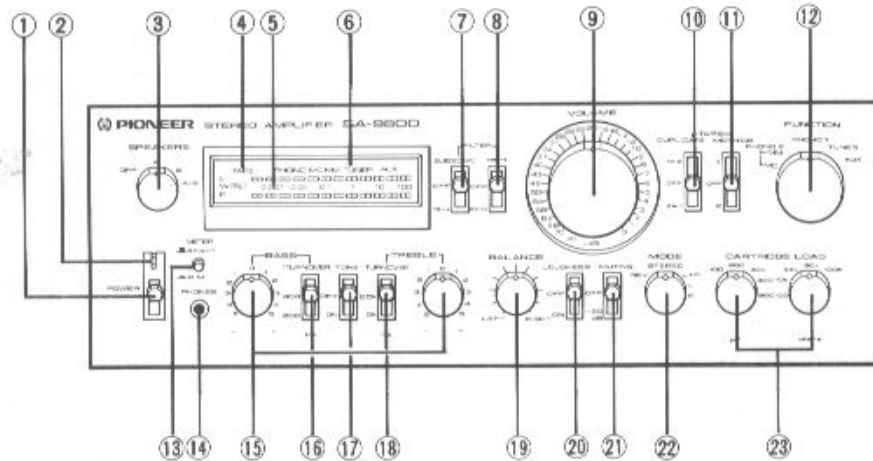

Fig. 6

FRONT PANEL FACILITIES



① POWER SWITCH

Set this switch to ON to supply power to the amplifier. There will be a short delay when it is set to ON, because the muting circuit has been actuated to suppress the unpleasant noise that is sometimes generated when the power is on and off.

② POWER INDICATOR

When the power switch is set to ON, this lamp lights up, indicating the amplifier is turned on.

③ SPEAKER SELECTOR

Use this selector to select the speaker systems.

OFF: Sound not obtained from speakers.

A: Sound obtained from speakers connected to the A speaker terminals.

B: Sound obtained from speakers connected to the B speaker terminals.

A+B: Sound obtained from speakers connected to both A and B speaker terminals.

④ TAPE MONITOR INDICATOR

The TAPE lamp lights up when the tape monitor switch is set to either position "1" or "2".

⑤ POWER METER

This meter allows you to read out the rated power level on the fluorescent display tube when speakers with a nominal impedance of 8 ohms are connected to the amplifier's speaker terminals.

⑥ FUNCTION INDICATORS

The PHONO, MC, MM, TUNER, AUX function indicators light up in accordance with the position of the function selector.

NOTE:

The function indicator will not go off when the tape monitor switch is set to position "1" or "2". This indicates a program at the recording source end during the monitoring of a recording.

⑦ SUBSONIC FILTER SWITCH

When this switch is set to the 15Hz position, the subsonic filter with a cut-off frequency of 15Hz is actuated. The subsonic filter serves to attenuate frequencies lower than 15Hz in a 12dB/oct slope. It is therefore effective in suppressing ultra-low frequency noise which is generated by record warp and other causes. You cannot actually hear this noise but it is a factor in the generation of intermodulation distortion and it may damage your speaker system. Set this switch to the 15Hz position during record play for the best effect.

⑧ HIGH FILTER SWITCH

The high filter with a cut-off frequency of 8kHz is actuated when this switch is set to the 8kHz position.

The high filter serves to attenuate frequencies higher than 8kHz in a 12dB/oct slope. This is why it is effective in suppressing high-frequency noise or noise from scratches on records being played.

⑨ VOLUME CONTROL

Use this control to adjust the output level to the speakers and headphones. Turn it clockwise to increase the output level. No sound will be heard if you set it to ∞. The scale is graduated in dB which indicate the attenuation when the maximum output level is 0dB.

⑩ TAPE DUPLICATE SWITCH

Use this switch when employing two tape decks to duplicate recorded tapes or edit tapes. This switch is otherwise kept at the OFF position.

1▶2: When playing back the tape on a deck connected to the TAPE 1 jacks and recording (duplicating) on a deck connected to the TAPE 2 jacks.

OFF: Set to this position when not duplicating.

2▶1: When playing back the tape on a deck connected to the TAPE 2 jacks and recording (duplicating) on a deck connected to the TAPE 1 jacks.

⑪ TAPE MONITOR SWITCH

Use this switch to select the program source which is being reproduced.

1: Set here to monitor a recording or a tape being played back on a tape deck which is connected to the TAPE 1 jacks.

OFF: Set here whenever you are not playing back a tape or monitoring a recording (i.e. when you have set the function selector to PHONO 1, PHONO 2 MM, MC, TUNER, or AUX for an alternative program source).

2: Set here to monitor a recording or a tape being played back on a tape deck which is connected to the TAPE 2 jacks.

⑫ FUNCTION SELECTOR

Use this selector to select the program source. When set, the function indicator above the meter panel corresponding to the position of the function selector will light up.

PHONO 2 MC: Set here when playing records on a turntable with a moving coil (MC) cartridge connected to the rear PHONO 2 jacks.

(The PHONO MC function indicator lights up.)

PHONO 2 MM: Set here when playing records on a turntable with a moving magnet (MM) cartridge connected to the rear PHONO 2 jacks.

(The PHONO MM function indicator lights up.)

PHONO 1: Set here when playing records on a turntable connected to the PHONO 1 jacks. (The PHONO MM function indicator lights up.)

If you intend to play a record on a turntable with a moving coil cartridge, connect the turntable to the rear PHONO 2 jacks and then set the function selector to the PHONO 2 MC position.

TUNER: Set here when listening to broadcasts on a tuner connected to the TUNER jacks. (The TUNER function indicator lights up.)

AUX: Set here when listening to a program source which is connected to the AUX jacks.

(The AUX function indicator lights up.)

NOTE:

When the function selector is set to the PHONO 2 MM or PHONO 1 position, you can select the input circuit resistance and the input capacitance in line with the load impedance of the cartridge being used with the CARTRIDGE LOAD selectors (ohms and pF).

⑬ METER SWITCH

This allows you to select the brightness of the meter panel.

BRIGHT (released position): This brightens the meter panel.

DIM (depressed position): This dims the meter panel. When your listening room is dark and the meter panel is too bright, set the switch to the DIM position.

⑭ HEADPHONE JACK

Plug the headphones into this jack when you want to listen through your stereo headphones.

NOTE:

Set the speaker selector to OFF when listening only with headphones.

⑮ BASS AND TREBLE CONTROLS

Use these controls to adjust the bass and the treble. If you set the tone switch to ON and turn the bass control to right from its center position, you will be able to emphasize the sound in a frequency range is lower than that selected by the bass turnover switch.

Conversely, turning this control from the center position to the left will attenuate the sound.

You can use the treble control to adjust the sound in a frequency higher than that selected by the treble turnover switch. For further details, refer to "TURNOVER SWITCHES" on page 10.

⑯ BASS TURNOVER SWITCH

Use this switch to change over the frequency in which the sound adjustment with the bass control is starting to take effect. Select 200Hz or 400Hz in accordance with the characteristics of your listening room and of your speakers, and with your general preference.

17 TONE SWITCH

Set this switch to ON when adjusting the bass and treble controls. When set to OFF, the tone control circuits are disengaged and frequency response is flat. This function is convenient for checking phono cartridge and speaker tone quality and listening room acoustics.

18 TREBLE TURNOVER SWITCH

Use this switch to change over the frequency in which the sound adjustment with the treble control is starting to take effect. Select 2.5kHz or 5kHz in accordance with the characteristics of your listening room and of your speakers, and with your general preference.

19 BALANCE CONTROL

Use this control to balance the volume of the left and right channels. First, however, set the mode selector to mono (L+R, L, or R), and adjust so that the sound appears to come from somewhere exactly between the two speakers. If the sound appears to be louder on the right, it means that the volume of the right channel is higher. Turn the balance control to the left and adjust.

Conversely, if the sound appears to be louder on the left, it means that the volume of the left channel is higher. Therefore, turn the balance control to the right and adjust. After adjusting, return the mode selector to STEREO.

20 LOUDNESS SWITCH

When listening to a performance with the volume control turned down, set this switch to ON and the bass and treble will be accentuated.

When the volume is low, the human ear finds it harder to hear the bass and treble than when the volume is high. The loudness switch is thus designed to compensate for this deficiency. By setting it to ON, the bass and treble come through much more strongly and the sound takes on a punch even when the volume control is turned down.

21 MUTING SWITCH

Set this switch to -20dB to attenuate the audio output indicated by the volume control by 20dB. There is no need to adjust the volume control if you use this switch when turning down the audio output temporarily and when changing over records or tapes.

22 MODE SELECTOR

Use this selector for selecting the performances.

REV: Reverses left and right channel stereo signals and reproduces them stereophonically.

STEREO: Set to this position for normal stereo reproduction.

L+R: Mixes left and right channel signals and reproduces them monophonically.

L: Left channels signal is reproduced monophonically from both speakers.

R: Right channel signal is reproduced monophonically from both speakers.

23 CARTRIDGE LOAD SELECTORS (ohms and pF)

These selectors allow you to select the input resistance and input capacitance in line with the rated load impedance and load capacitance of a moving magnet (MM) cartridge for record play.

Use these two switches to produce the sound quality of your preference or the ideal conditions for your cartridge.

TURNOVER SWITCHES

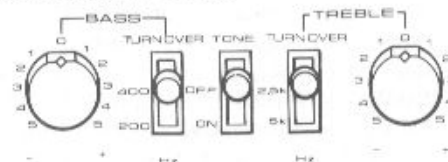

This amplifier adopts a tone control system that combined bass and treble controls with two turnover switches which are used to select the frequency. Select the frequency with the turnover switches and then enhance or attenuate the sound in the lower (or higher) frequencies with the bass (or treble) controls.

For instance, if the bass turnover switch is set to 400Hz (see Fig. 7), the bass covers a wide with large gain per step of the bass control. For this reason, the reproduced sound sometimes seems unnatural depending on the program source, but this can be remedied by setting the switch to 200Hz.

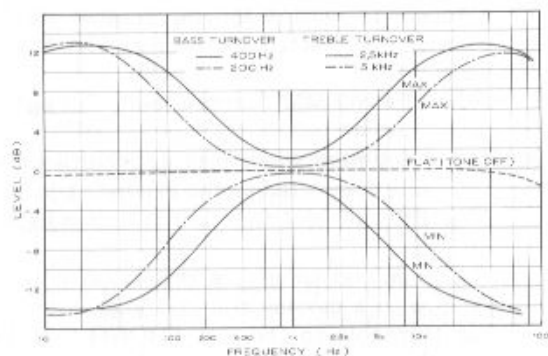
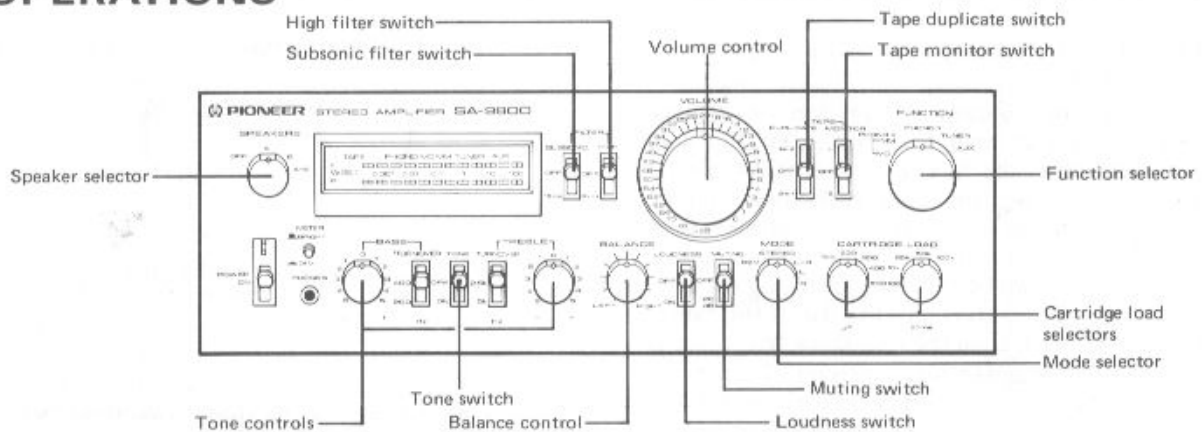

Fig. 7

OPERATIONS



PRIOR TO SWITCHING POWER ON

Before switching the power on, set the various controls as follows:

1. Set the subsonic filter switch to OFF.
2. Set the high filter switch to OFF.
3. Set the volume control to ∞.
4. Set the tape duplicate switch to OFF.
5. Set the tape monitor switch to OFF.
6. Set the tone switch to OFF.
7. Set the balance control to the center position.
8. Set the loudness switch to OFF.
9. Set the muting switch to OFF.
10. Set the mode selector to STEREO.
11. Set the tone controls to the center positions.
12. Set the speaker selector to the appropriate position according to the employed terminals.

PLAYING RECORDS

1. Set the function selector to PHONO 1 when your turntable is connected to the PHONO 1 jacks. Set to PHONO 2 MM when the turntable is connected to the PHONO 2 jacks.

NOTE:

When using a moving coil (MC) cartridge, connect the turntable to the PHONO 2 jacks then set the function selector to PHONO 2 MC.

2. Set the cartridge load selectors in accordance with the cartridge's specified load resistance and load capacitance. For further details, refer to "LOAD RESISTANCE AND LOAD CAPACITANCE" on page 12.

NOTE:

When setting the function selector to PHONO 2 MC and employ a moving coil (MC) cartridge, you will not be able to vary the load resistance and load capacitance even if you rotate the cartridge load selectors.

3. Operate the turntable to play the record.

4. Adjust the volume with the volume control.

5. Set the tone switch to ON in line with your preference and adjust the tone with the tone controls.

Precautions when playing records.

- Lower the stylus gently on to the surface of the record. It is a good idea to set the muting switch to -20dB or to turn the volume down when lowering the stylus onto the record.
- Set the subsonic filter switch to 15Hz when there is a great deal of noise in the low-frequency region or when the bass speaker's diaphragm moves even though no sound can be heard during a performance.
- Do not cause the turntable to vibrate while a record is being played since this will cause the stylus to jump and scratch the record. Do not turn off the power if the stylus is still tracing grooves on the record.

LISTENING TO THE BROADCAST

1. Set the function selector to TUNER.
2. Operate the tuner and tune in to the desired station.
3. Adjust the volume with the volume control.
4. Set the tone switch to ON in line with your preference and adjust the tone with the tone controls.

USING THE AUX JACKS

1. Set the function selector to AUX.
2. Operate the audio component which you have connected to the AUX jacks.
3. Adjust the volume with the volume control.
4. Set the tone switch to ON in line with your preference and adjust the tone with the tone controls.

EFFECTIVE OPERATIONS

LOAD RESISTANCE AND LOAD CAPACITANCE

Typical moving magnet (MM) cartridges have resonance peaks at high frequencies, as shown in Fig. 9). However, the height of the peaks can be varied by changing the load resistance (ohms). The peaks increase as the resistance is increased. In addition, the resonance frequency (center of the peak frequency) can be varied by changing the load capacitance (pF), as shown in Fig. 10. If the capacitance is increased, then the resonance frequency is lowered and the peaks are increased. To provide the best characteristics of your cartridge, set the "pF" and "ohms" switches, following the instructions outlined below. By combining these two knobs, you will be able to obtain a variety of different high-frequency responses.

When the phono cartridge load resistance and capacitance are specified

- Set the specified load resistance with the "ohms" knob.
- Subtract the turntable capacitance (stray capacitance of the output cord, tonearm, etc.) from the cartridge's specified capacitance and select this value with the "pF" knob.

NOTES:

- Refer to the operating instructions of the cartridge for the specified load resistance and capacitance values.
- When the load resistance switch is at 100Ω position, the sound volume will be reduced.
- Since the turntable capacitance varies with the output cord, wiring and other factors, a precise value cannot be definitely determined. In general, however, it can be considered to be in the range of 100pF to 200pF. Adjust the load capacitance while listening to a record.
- The capacitance of Pioneer's turntables ranges from 75pF to 150pF. Subtract the capacitance from the load capacitance shown in the table, and then set the switch to the value which is closest to the resulting figure. For example, say you are using the PC-550E/II by Pioneer. Subtract 100pF from 170pF which gives 70pF. Set the cartridge load capacitance switch to the closest figure, which is "100pF".

When not specified

The example in Fig. 10. shows typical high-end frequency curves. In a case like this, adjust both switches for the desired response while listening to a record. With ordinary MM cartridges, the values are 50 kilohms and 100pF ~ 200pF.

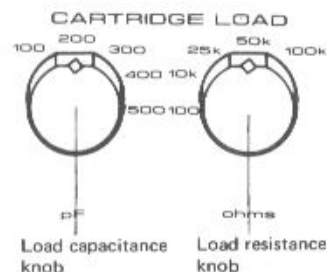

Fig. 8

Examples of Frequency Response Variations due to the Cartridge Load Resistance Switch Settings.

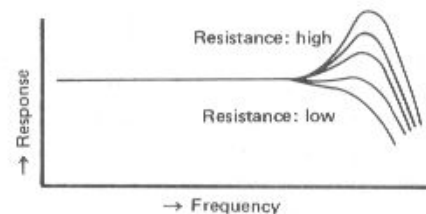

Fig. 9

Examples of Frequency Response Variations due to the Cartridge Load Capacitance Switch Settings.

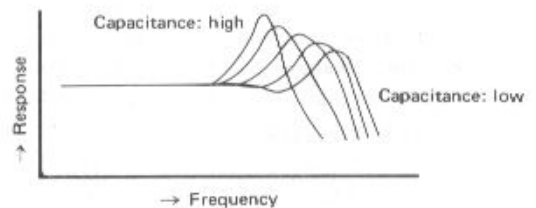

Fig. 10

Makers of cartridges and recommended loads

Manufacturer	Cartridge		Load resistance (ohms)	Load capacitance (pF)
	Power generating type			
Pioneer	PC-550E/II (MM)		47k	170
ADC	XLM MKII (IM)		47k	275
AKG	P8E (MI)		47k	400
Empire	2000Z (MI)		47k	300
Ortofon	VMS20E (MI)		47k	400
Shure	V15 TYPE IV (MM)		47k	200~300
Stanton	680 EE (MI)		47k	275

USING THE TAPE DECKS

PLAYBACK

1. As shown in Fig. 11, set the tape monitor switch to 1 if the tape deck is connected to the TAPE 1 jacks. Set the tape monitor switch to 2 if it is connected to the TAPE 2 jacks.
2. Operate the tape deck controls for playback.
3. Adjust the volume with the volume control.
4. Set the tone switch to ON in line with your preference and adjust the tone with the tone controls.

NOTE:

Always set the tape monitor switch to the OFF position when you are not playing back a tape.

RECORDING

1. Set the function selector to the program source to be recorded.
2. Set the tape duplicate switch to the OFF position.
3. Set recording level by means of the controls on the tape deck.
4. Operate the tape deck controls and start recording.

NOTE:

The volume, tone controls, balance control and loudness switch have no effect at all on signals from the REC jacks of the stereo amplifier.

Tape Monitoring

If a recording is being made on a 3-head tape deck, the recorded sound can be monitored through the speaker system if the tape monitor switch is set to 1 or 2. In this case, both recording and playback connections must be made.

NOTE:

If you have a 2-head open-reel deck or cassette deck, you will not be able to monitor the recorded sound even if you set the tape monitor switch to 1 or 2. However, you will be able to hear the sound at the playback end (program source).

DUPLICATING AND EDITING RECORDED TAPES

1. Connect the two tape decks as shown in Fig. 13.
2. When duplicating the contents of a recorded tape in tape deck 1 onto a blank tape in tape deck 2, set the tape duplicate switch to 1 ▶ 2. When duplicating from deck 2 to deck 1, set this switch to 2 ▶ 1.
3. When you want to monitor the quality of the sound being recorded, set the tape monitor switch to 1 or 2.

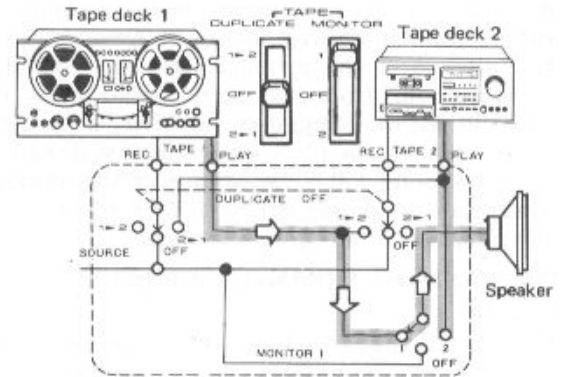

Fig. 11

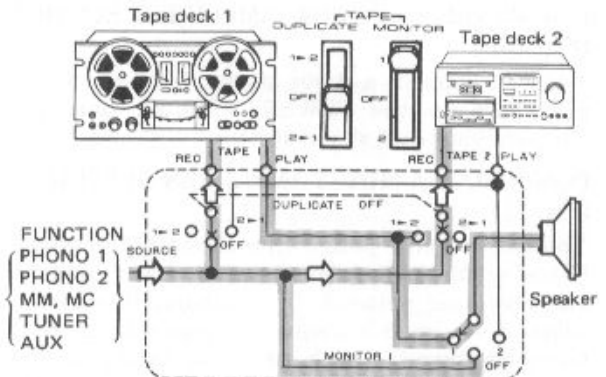
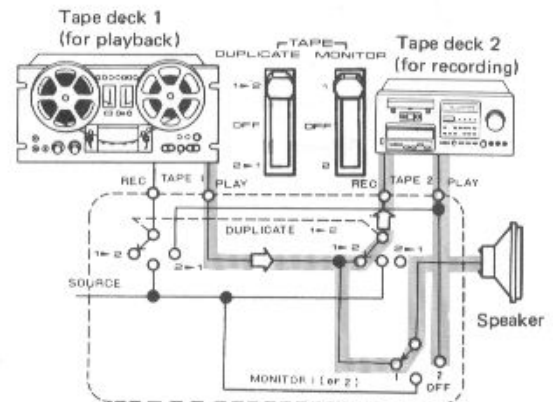

Fig. 12



Set the tape duplicate switch to 1 ▶ 2 when recording from tape deck 1 to tape deck 2.

Fig. 13

NOTE:

Do not record programs simultaneously on both tape deck 1 and tape deck 2.

USING PRE OUT AND POWER AMP IN JACKS

As explained below, you can use the preamplifier and power amplifier of the SA-9800 separately if you disconnect the preamplifier/power amplifier connector bar from the jacks. When using the SA-9800 as an integrated amplifier, keep these connector bars in place since once you remove them, no sound will be heard through the speakers. Always set the power switch to OFF when removing or replacing these connector bars.

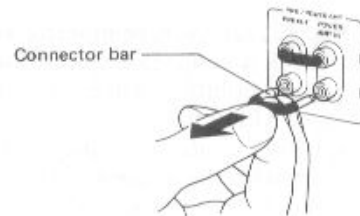

Fig. 14

INDEPENDENT PREAMPLIFIER SECTION (Fig. 15)

You can connect a high output power stereo amplifier or a home-built power amplifier to the PRE OUT jacks and compare the sound with the power amplifier section of the stereo amplifier.

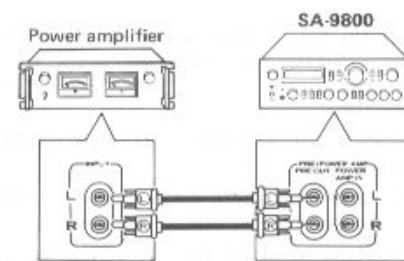

Fig. 15

INDEPENDENT POWER AMPLIFIER SECTION (Fig. 16)

You can connect a stereo preamplifier which you may have to the POWER AMP IN jacks and compare your own stereo system.

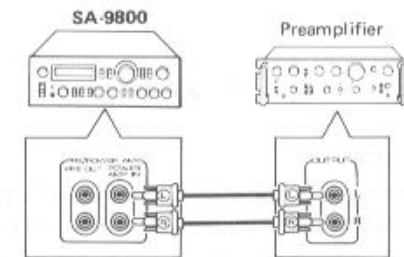

Fig. 16

COMPOSING A MULTI-AMPLIFIER SYSTEM (Fig. 17)

You can compose your own multi-amplifier system if you connect an optional stereo power amplifier and crossover network. A multi-amplifier system splits up the audible frequency range into different frequency bands. Each of these bands is then amplified by the amplifiers and so this has the advantage of reducing intermodulation distortion.

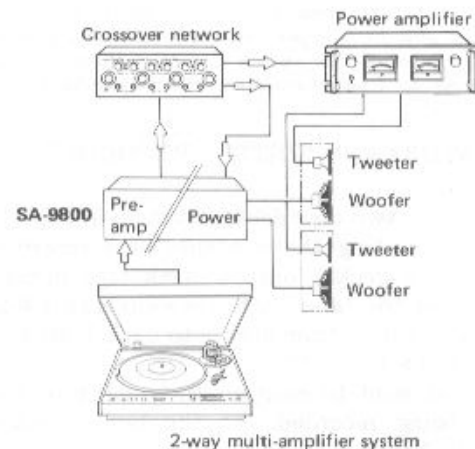

Fig. 17

CONDITIONS FREQUENTLY MISTAKEN FOR MALFUNCTIONS

In event of suspected malfunction, check the unit according to the following table and confirm proper operation of other connected equipment. If the difficulty cannot be corrected, turn off the power and contact a Pioneer authorized service center.

Symptom	Diagnosis check points	Remedy
No sound	<ul style="list-style-type: none"> Is power indicator light on? 	<ul style="list-style-type: none"> Plug power cord securely into power outlet. Set power switch to ON.
	<ul style="list-style-type: none"> Are speakers, tuner, tape deck and other components connected properly? 	<ul style="list-style-type: none"> Connect properly. (If all components are connected properly, check the components themselves).
	<ul style="list-style-type: none"> Check preamplifier/power amplifier connector bar on rear panel. 	<ul style="list-style-type: none"> Plug the bar in the jack securely.
	<ul style="list-style-type: none"> Is function selector set to correspond to program source? 	<ul style="list-style-type: none"> Set so that the switch corresponds to the source.
	<ul style="list-style-type: none"> Check tape monitor switch position. 	<ul style="list-style-type: none"> Set to OFF except for tape playback. Refer to page 13.
	<ul style="list-style-type: none"> Check speaker selector position. 	<ul style="list-style-type: none"> Select in accordance with the speaker terminals to which speakers are connected.
	<ul style="list-style-type: none"> Check positions of muting switch and volume control. 	<ul style="list-style-type: none"> Set muting switch to OFF, and rotate volume control clockwise.
	<ul style="list-style-type: none"> Sound not heard immediately even though power switch is set to ON. 	<ul style="list-style-type: none"> Sound will not be heard for several seconds due to actuation of the muting circuit. See page 8.
Occasional noise heard.	<ul style="list-style-type: none"> Are components connected properly? 	<ul style="list-style-type: none"> Connect to as to eliminate faulty contacts. (Noise may decrease when ground wire is connected.)
	<ul style="list-style-type: none"> Any problem with connected components? 	<ul style="list-style-type: none"> Correct fault.
Sound quality remains unaltered.	<ul style="list-style-type: none"> Check positions of tone and muting switches. 	<ul style="list-style-type: none"> Set tone switch to ON and muting switch to OFF.
Howl caused when volume is raised.	<ul style="list-style-type: none"> Turntable and speakers are too close to one another. 	<ul style="list-style-type: none"> Try changing the installation locations of the turntable and speakers.
	<ul style="list-style-type: none"> Installation locations of turntable and speakers are not stable. 	<ul style="list-style-type: none"> Do not turn up the bass controls excessively.

SPECIFICATIONS

Semiconductors

ICs	3
FETs	6
Transistors	73 (75; HG model)
Diodes	36
Others	3

Power Amplifier Section

Continuous Power Output is 100watts* per channel, min., at 8 ohms from 10 Hertz to 20,000 Hertz with no more than 0.005% total harmonic distortion, or 100 watts* per channel at 4 ohms from 10 Hertz to 20,000 Hertz with no more than 0.005% total harmonic distortion.

Continuous Power Output

10Hz to 50kHz	100W + 100W (T.H.D. 0.01%, 8 ohms)
	120W + 120W (T.H.D. 0.02%, 4 ohms)

Continuous Power Output at 1kHz (both channel driven)

T.H.D. 0.002%, 8 ohms	100 watts per channel
-----------------------	-----------------------

Total Harmonic Distortion (10 Hertz to 20,000 Hertz)

continuous rated power output	No more than 0.005%
50 watts per channel power output, 8 ohms	No more than 0.004%

1 watt per channel power output, 8 ohms	No more than 0.004%
---	---------------------

Intermodulation Distortion (50 Hertz : 7,000 Hertz = 4 : 1)

continuous rated power output	No more than 0.002%
50 watts per channel power output, 8 ohms	No more than 0.002%

1 watt per channel power output, 8 ohms	No more than 0.002%
---	---------------------

Frequency Response

5 to 200,000 Hertz	+0 dB
--------------------	-------

Input (Sensitivity/Impedance)

1V/50 kilohms	
---------------	--

Output Speaker

A, B, A+B	
-----------	--

Headphones

Low impedance	Low impedance
---------------	---------------

Damping Factor (20 Hertz to 20,000 Hertz, 8 ohms)

55	
----	--

Hum and Noise (IHF, short-circuited, A network)

118dB	
-------	--

Preamplifier Section

Input (Sensitivity/Impedance)

PHONO 1, 2 MM	2.5mV/50 kilohms
PHONO 2 MC	100µV/100Ω
CARTRIDGE LOAD	Both Phono 1 and 2

100, 10k, 25k, 50k, 100k ohms	
100, 200, 300, 400, 500pF	

TUNER, AUX, TAPE PLAY 1, 2	150mV/50 kilohms
----------------------------	------------------

TAPE PLAY 2 (DIN connector; HG model only)	
--	--

	30mV/80 kilohms
--	-----------------

Phono Overload Level (T.H.D. 0.002%, 1kHz)

PHONO 1	250mV
---------	-------

PHONO 2	250mV (MM), 10mV (MC)
---------	-----------------------

Output (Level/Impedance)

TAPE REC 1, 2	150mV
---------------	-------

TAPE REC 2 (DIN connector; HG model only)	
---	--

PRE OUT	1V/600 ohms, 3V/600 ohms (max.)
---------	---------------------------------

Total Harmonic Distortion

10 to 50,000 Hertz, 1V output	No more than 0.006%
-------------------------------	---------------------

Frequency Response

PHONO (RIAA Equalization)	20Hz to 20,000Hz +0.2dB
---------------------------	-------------------------

TUNER, AUX, TAPE PLAY	.5Hz to 100,000Hz \pm 1 dB
-----------------------	------------------------------

Tone Control

BASS	400Hz position +10dB, -10dB (100Hz)
------	-------------------------------------

200Hz position	+10dB, -10dB (50Hz)
----------------	---------------------

Turnover Frequency	400Hz/200Hz
--------------------	-------------

TREBLE	2.5kHz position +10dB, -10dB (10kHz)
--------	--------------------------------------

5kHz position	+10dB, -10dB (20kHz)
---------------	----------------------

Turnover Frequency	2.5kHz/5kHz
--------------------	-------------

Filter SUBSONIC

15Hz	(12dB/oct)
------	------------

HIGH	8kHz (12dB/oct)
------	-----------------

Hum and Noise (IHF, short-circuited, A network)

PHONO MM/MC	90dB/72dB
-------------	-----------

TUNER, AUX, TAPE PLAY	110dB
-----------------------	-------

Hum and Noise (DIN, Continuous Power/50mW)

PHONO 1 MM	72dB/62dB
------------	-----------

PHONO 2 MM	72dB/62dB
------------	-----------

TUNER, AUX, TAPE PLAY 1, 2	90dB/62dB
----------------------------	-----------

Hum and Noise (IHF A-202, '78)

PHONO 1 MM	78dB
------------	------

PHONO 2 MM	78dB
------------	------

TUNER, AUX, TAPE PLAY 1, 2	83dB
----------------------------	------

Muting

	-20dB
--	-------

Loudness Contour

	+6dB (100Hz), +3dB (10kHz)
--	----------------------------

Miscellaneous

Power Requirements

HG model; 220V/240V~, 50/60Hz	
-------------------------------	--

S, S/G models; 110V&120V/220V/240V, 50/60Hz	
---	--

Power Consumption

HG model; 850W (max.)	
-----------------------	--

S, S/G models; 250W (max.)	
----------------------------	--

Dimensions

HG, S models; 420(W) x 150(H) x 425(D) mm	
---	--

16-9/16(W) x 5-7/8(H) x 16-3/4(D) in	
--------------------------------------	--

S/G model; 453(W) x 155(H) x 425(D) mm	
--	--

17-11/16(W) x 6-1/8(H) x 16-3/4(D) in	
---------------------------------------	--

Weight (Without Package)

HG, S models; 18.0kg (39lb 11oz)	
----------------------------------	--

S/G model; 19.1kg (42lb 2oz)	
------------------------------	--

Furnished Parts

Operating instructions	1
------------------------	---

Fuse (S, S/G models only)	10A ; 1, 5A ; 1
---------------------------	-----------------

*Measured pursuant to Federal Trade Commission's Trade Regulation rule on Power Output Claims for Amplifier.

NOTE:

Specifications and the design subject to possible modification without notice due to improvements.

PIONEER ELECTRONIC CORPORATION 4-1, Meguro 1-Chome, Meguro-ku, Tokyo 153, Japan
U.S. PIONEER ELECTRONICS CORPORATION 85 Oxford Drive, Moonachie, New Jersey 07074, U.S.A.
PIONEER ELECTRONIC (EUROPE) N.V. Luithagen-Haven 9, 2030 Antwerp, Belgium
PIONEER ELECTRONICS AUSTRALIA PTY. LTD. 178-184 Boundary Road, Braeside, Victoria 3195, Australia